

37 018

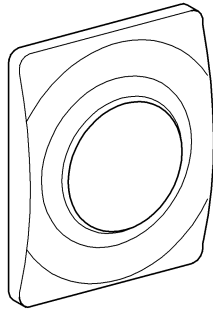

38 595

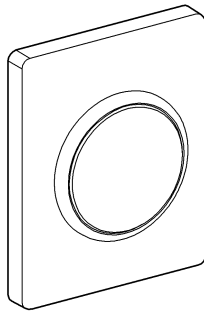

- D**1 **I**5
- GB**2 **NL**6
- F**3
- E**4

94.714.131/ÄM 207782/05.06

GROHE
ENJOY WATER®

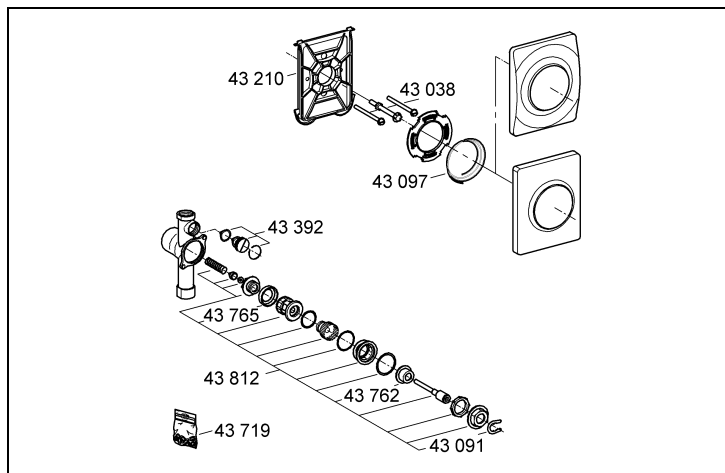
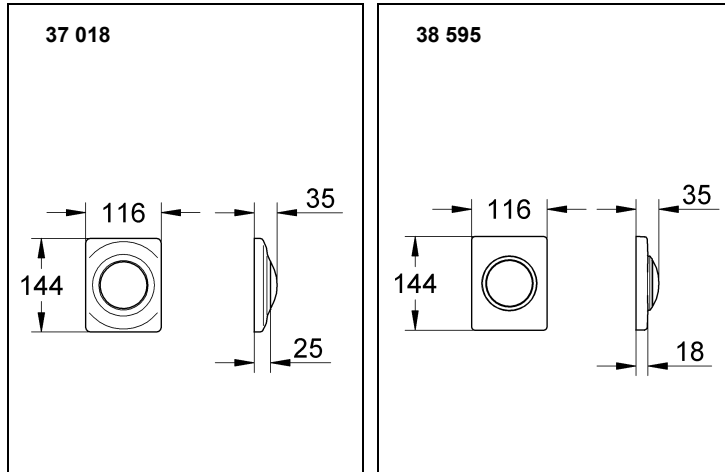

Bitte diese Anleitung an den Benutzer der Armatur weitergeben!
Please pass these instructions on to the end user of the fitting.
S.v.p remettre cette instruction à l'utilisateur de la robinetterie!

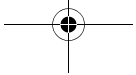
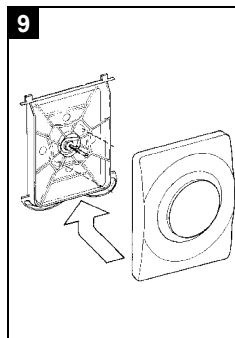
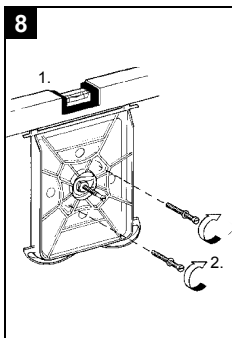
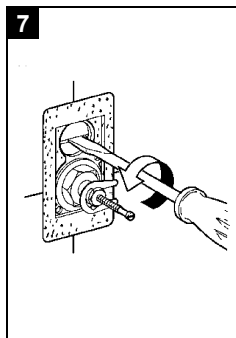
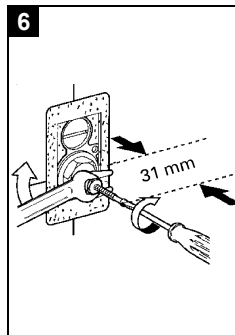
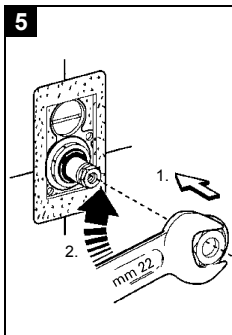
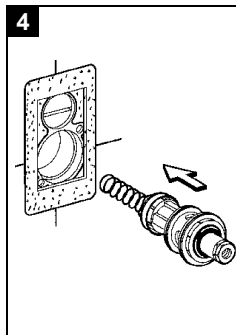
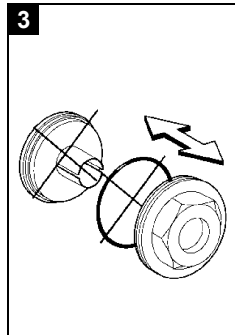
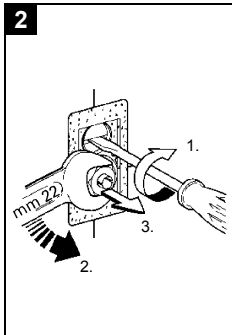
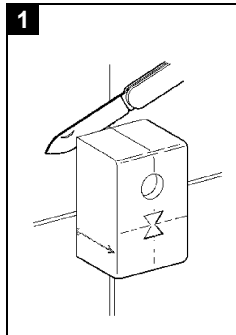

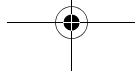
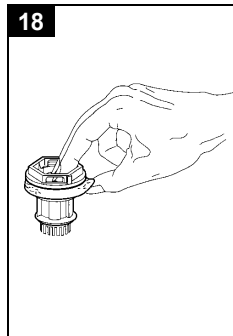
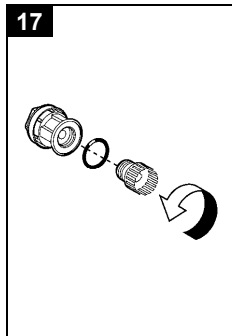
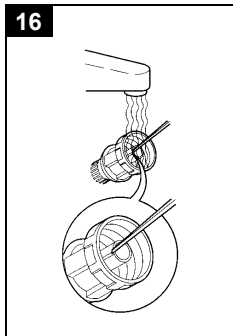
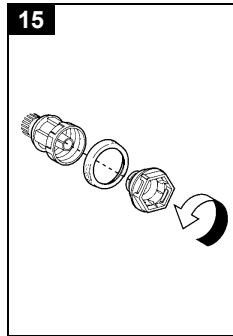
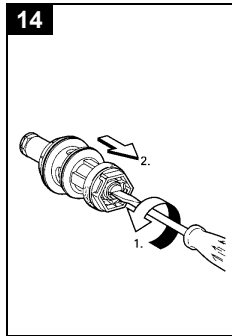
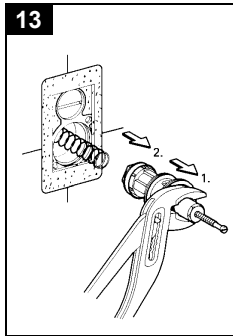
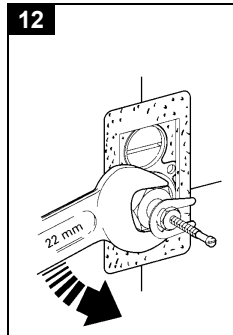
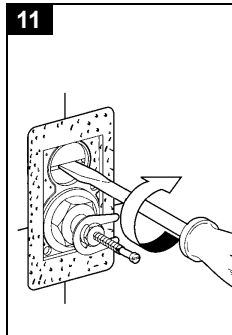
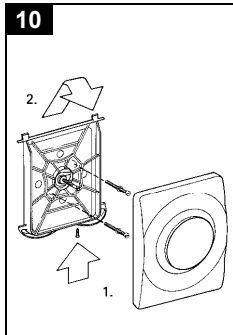

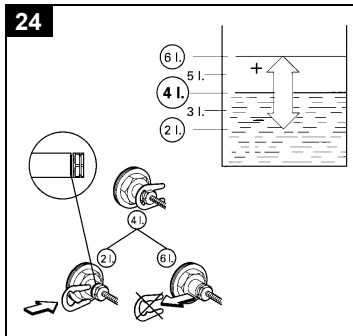
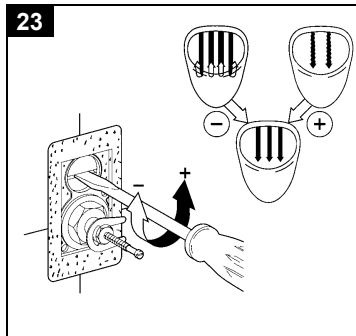
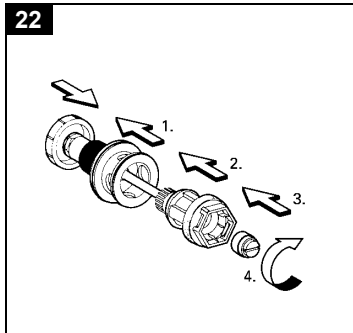
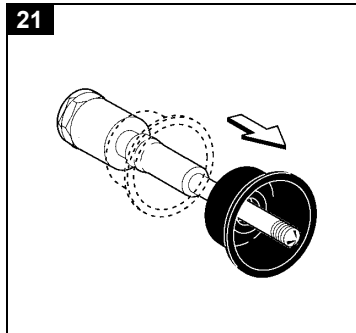
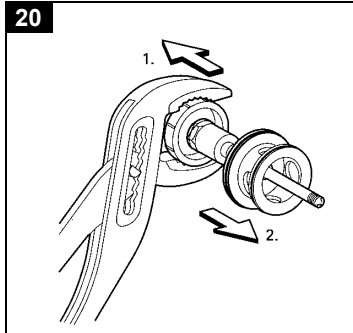
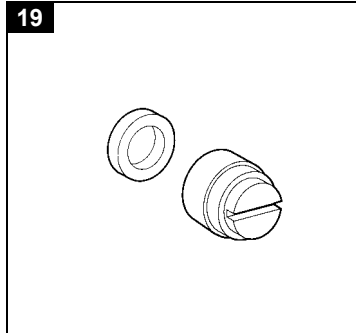



D



Störung

Ursache	Behebung	Abbildung
Dauerläufer		
Düse verstopft	reinigen	16
Dichtung am Entlastungsventil verschmutzt oder beschädigt	reinigen oder austauschen	19
Kolbendichtung beschädigt	austauschen	17
Spülung zu kurz		
Ledermanschette ausgetrocknet oder beschädigt	aufweiten oder austauschen	15+18
Einstellung falsch	prüfen	24
Wasser tritt an der Betätigungskappe aus		
Rollmembrane defekt	austauschen	20+21
Spülstrom zu gering oder zu stark		
Fließdruck zu gering oder zu stark	einstellen	23

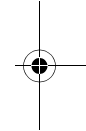
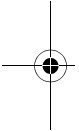

Funktionsteile der Armatur nicht einfetten

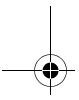

1

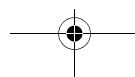
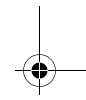

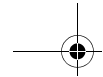

GB

Problem

Cause	Remedy	Figure
Valve does not close		
Jet is clogged	clean	16
Gasket at relief cone is clogged or damaged	clean or exchange	19
Washer of piston is damaged	exchange	17
Flush time too short		
Leather washer is defective or dried out	exchange or widen it	15+18
Wrong adjustment	check	24
Water emerges below operating cap		
Diaphragm is defective	exchange	20+21
Flow rate too low or too strong		
Flow pressure too low or too strong	adjust	23

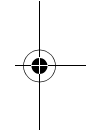
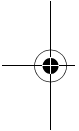

Do not lubricate internal parts of the flush valve

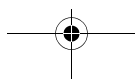
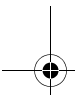

2

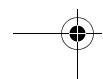
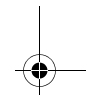

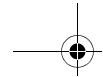

F

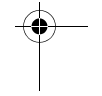

Panne

Cause

Remède

Illustration

Écoulement continu

Le gicleur est bouché
Le joint de la soupape de décharge est sale ou défectueux
Le joint du piston est abîmé

nettoyer
nettoyer ou changer
changer

16
19
17

Rinçage trop court

Manchette de cuir asséchée
Mauvaise installation

élargir ou changer
Vérifier

15+18
24

De l'eau s'échappe de la plaque de commande

La manchette de l'axe est défectueuse

changer

20+21

Débit trop faible ou trop fort

Pression dynamique trop faible ou trop forte

mise au point du réglage

23

Ne pas graisser les parties fonctionnelles

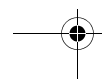
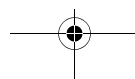
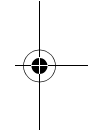
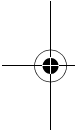

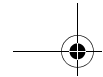

E



Problema

Causa	Remedio	Figura
Tobera atascada	limpiar	16
Sellado en la válvula de descarga sucio o dañado	limpiar o sustituir	19
Empaquetadura del émbolo dañada	sustituir	17

Descarga demasiado breve

Manguito de piel seco o dañado	ampliar o sustituir	15+18
Ajuste incorrecto	comprobar	24

Pérdida de agua del cabezal de accionamiento

Membrana dañada	sustituir	20+21
-----------------	-----------	-------

Fuerza de descarga demasiado alta o demasiado baja

Presión de flujo demasiado reducida o demasiado elevada	ajustar	23
---	---------	----

No lubricar las partes internas de la válvula de descarga

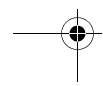
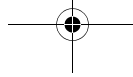

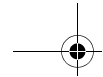

I

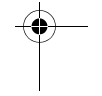

Guasto

Causa	Rimedio	Figura
Erogazione continua		
Forellino otturato	pulirlo	16
Guarnizione del cono di scarico sporca o danneggiata	pulire o sostituire	19
Guarnizione del pistone danneggiata	sostituire	17
Erogazione troppo breve		
Guarnizione di cuoio essicata o danneggiata	allargarla o sostituirla	15+18
Taratura sbagliata	controllare	24
Perdita d'acqua dal cappuccio di azionamento		
Membrana difettosa	sostituirla	20+21
Forza di sciacquo troppo debole o troppo forte		
Pressione dinamica scarsa o eccessiva	regolare la pressione	23

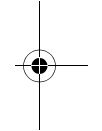
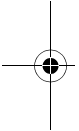

Non ingrassare le parti funzionanti

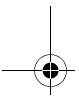

5

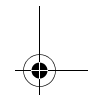
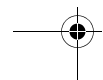
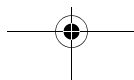

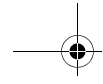

NL

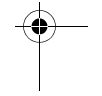

Storing

Oorzaak	Opheffing	Afbeelding
Water blijft stromen		
Sproeikop verstopt	reinen	16
Afdichting aan de ontlastingsdichting vervuild of beschadigd	reinen of vervangen	19
Dichting van de zuiger beschadigd	vervangen	17

Spoeling te kort

Leren pakking uitgedroogd of beschadigd	soepel maken of vervangen	15+18
Verkeerd ingesteld	controleren	24

Er komt water onder de bedieningskap vandaan

Rolmembraan defect	vervangen	20+21
--------------------	-----------	-------

Spoelstroom te gering of te sterk

Dynamische druk te gering of te sterk	instellen	23
---------------------------------------	-----------	----

Funcieonderdelen van de armatuur niet invetten

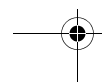
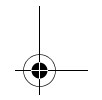
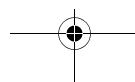
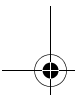
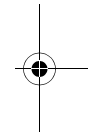
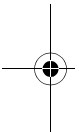

(D)

Grohe Deutschland
Vertriebs GmbH
Zur Porta 9
32457 Porta Westfalica
Tel.: +49 571 3989-333
Fax: +49 571 3989-999

(A)

GROHE Ges.m.b.H.
Beichlgasse 6
1100 Wien
Tel.: +43 1 68060-0
Fax: +43 1 6898747

(B)

GROHE nv - sa
Diependaalweg 4a
3020 Winksele
Tel.: +32 16 230660
Fax: +32 16 239070

(BG)

Представителство
Grohe AG
в България
Ранф Ширинг
Клов 11, П.К. 35
8011 Буярас
тел./факс.: +359 56 950104
тел./факс.: +359 56 845549

(CDN)

GROHE Canada Inc.
1226 Lakeshore Road East
Mississauga, Ontario
Canada, L5E 1E9
Tel.: +1 905 2712929
Fax: +1 905 2719494

(CH)

Grohe Switzerland SA
Hertistrasse 2
8304 Wallisellen
Tel.: +41 44 8777300
Fax: +41 44 8777320

(CN)

高仪 (上海)
卫生洁具有限公司
宁桥路615号
201206 上海
中华人民共和国
电话: +86 21 50323535
传真: +86 21 50550363

(CY)

Nicos Theodorou & Sons Ltd.
12 Dimitsanis Street
CY-1507 Nicosia
P.O. Box 21387
Tel.: +357 22 757671
Fax: +357 22 759085

(CZ)

Zastoupení
Grohe AG pro ČR a SR
V Obilku 104, Čestlice
252 43 Příhonic
Tel.: +420 225 091 081-4
Fax: +420 225 091 085

(SK)

Zastoupení
Grohe AG pro ČR a SR
V Obilku 104, Čestlice
252 43 Příhonic
Tel.: +420 225 091 081-4
Fax: +420 225 091 085

(DK)

GROHE A/S
Weigenholm 11
3500 Vaerløse
Tel.: +45 44 656800
Fax: +45 44 650252

(E)

GROHE España S.A.
C/ Botanica, 78 - 88
Gran Via L'H - Distr. Econòmic
08908 L'Hospitalet de Llobregat
(Barcelona)
Tel.: +34 93 3368850
Fax: +34 93 3368851

(EST)

ALPIGRO OÜ
Alar Pihlak
Jõe 5
10151 Tallinn
Tel.: +372 6261204
Fax: +372 6261204

(F)

GROHE s.à.r.l.
11, Rue des Peupliers
92441 Issy-les-
Moulineaux Cedex
Tel.: +33 1 46625000
Fax: +33 1 46626110

(FIN)

Oy Teknocalor Ab
Sinikellonkuja 4
01300 Vantaa
Tel.: +358 9 8254600
Fax: +358 9 8261511

(GB)

GROHE Limited
1, River Road
Barking, Essex, IG11 0HD
Tel.: +44 208 5947292
Fax: +44 208 5948898

(GR)

Nikos Sapountzis S.A.
86, Kapodistriou & Roumelis Str.
142 35 N. Ionia - Athens
Tel.: +30 10 2712908
Fax: +30 10 2715608

(H)

GROHE Hungary Kft.
Liget u. 1.
2040 Budaörs
Tel.: +36 23 422 468
Fax: +36 23 422 469

(HR)

ENERTECH GmbH
Division Giersch
Maksimirska 96/II
10000 Zagreb
Tel.: +385 1 2338260
Fax: +385 1 2308024

(I)

GROHE S.p.A.
Via Castellazzo Nr. 9/B
20040 Cambiago (Milano)
Tel.: +39 2 959401
Fax: +39 2 95940263

(IS)

BYKO hf.
Skennumvegji 2
200 Kópavogur
Tel.: +354 515 4000
Fax: +354 515 4099

(J)

Grohe Japan Ltd.
TRC Building, 3F
1-1 Heiwajima 6-chome, Ota-ku
Tokyo 143-0006
Tel.: +81 3 32989730
Fax: +81 3 37673811

(N)

GROHE A/S
Karihaugveien 89
1086 Oslo
Tel.: +47 22 906110
Fax: +47 22 906120

(NL)

GROHE Nederland BV
Metaalstraat 2
2718 SW Zoetermeer
Tel.: +31 79 3680133
Fax: +31 79 3615129

(P)

GROHE Portugal
Componentes Sanitários, Lda.
Rua Arq. Cassiano Barbosa, 539
1.º Frente Esquerdo
4100-009 Porto
Tel.: +351 22 543 29 80
Fax: +351 22 543 29 99

(PL)

GROHE Polska Sp. z o.o.
Ul. Migdalowa 4
02-796 Warszawa
Tel.: +48 22 6451255 - 57
Fax: +48 22 6451258

(RUS)

Представительство
Grohe AG
Москва, ул. Цинко, 11/28, стр. 1
115054
тел.: +7 095 9374901
факс: +7 095 9374902

(RO)

S.C. EURO - International S.R.L.
B-dul Dincu Golescu Nr. 41, Bl.6,
Sc. 3, Ap. 67, Parter
010860 Bucharest (Sector 1)
Tel.: +40 21 3161451
Fax: +40 21 3161452

(S)

GROHE A/S
Box 2053
194 02 Upplands Väsby
Tel.: +46 771 141314
Fax: +46 771 141315

(SLO)

GROSAN inženiring d.o.o.
Slandrova 4
1000 Ljubljana
Tel.: +386 1 5633060
Fax: +386 1 5633061

(TR)

GROME İc ve Dis Ticaret Ltd. Sti.
Bağdat Cad. Uğras Panar Is
Merkezi No: 305, B Blok D: 12 - 15
34846 Cevizli - Maltepe-Istanbul
Tel.: +90 216 4412370
Fax: +90 216 3706174

(UA)

Представитель
Grohe AG
в УКРАИНЕ
Н.И. Топольская
03151 Киев
тел.: +38 44 2751734
факс: +38 44 2498458

(USA)

GROHE America Inc.
241 Covington Drive
Bloomington
Illinois, 61708
Tel.: +1 630 5827711
Fax: +1 630 5827722

Near and Middle East
Area Sales Office:
GROME Marketing
(Cyprus) Ltd.

11, Lemessou Avenue
Galatariotis Building 1st floor
2112 Aglanija
P.O. Box 27048
1641 Nicosia
Tel.: +357 22 465200
Fax: +357 22 379188

Far East Area Sales Office:
GROHE Pacific Pte. Ltd.
280 Orchard Road
#08-03/04 The Heeren
Singapore 238855
Tel.: +65 6738 5585
Fax: +65 6738 0855

GROHE
ENJOY WATER®