

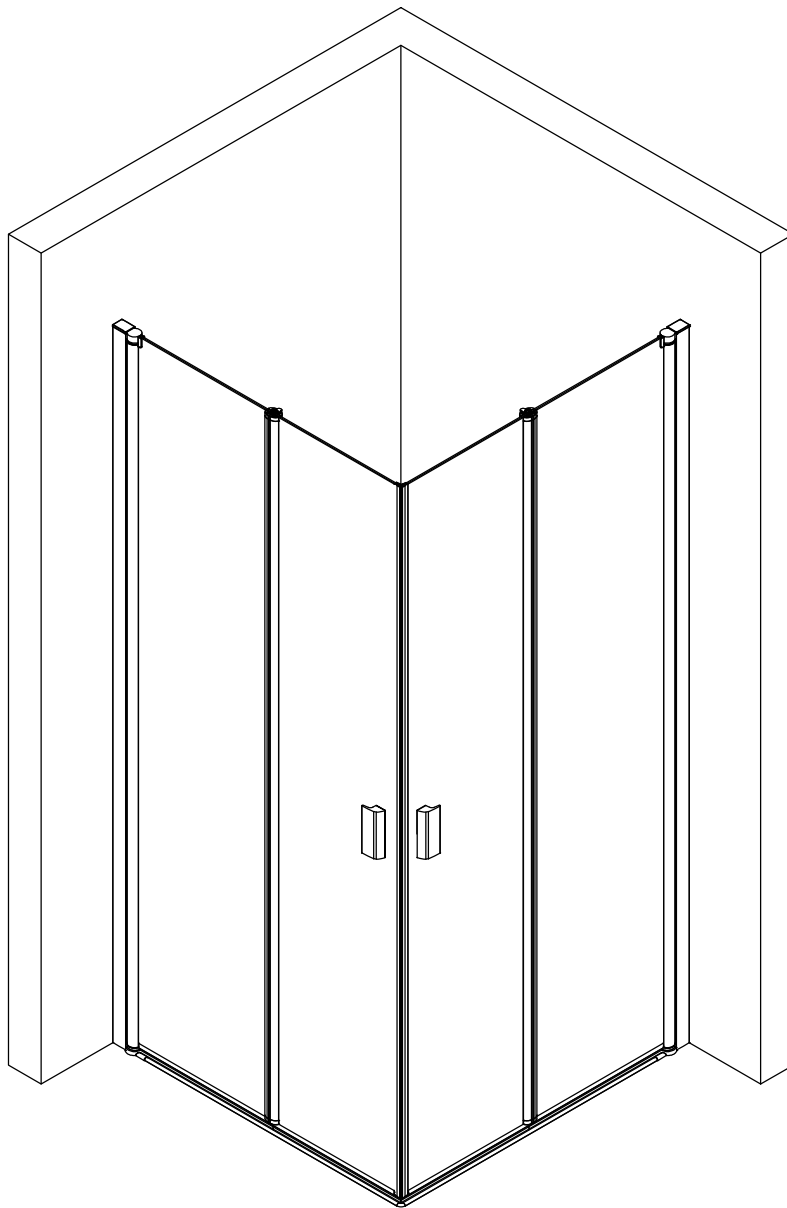

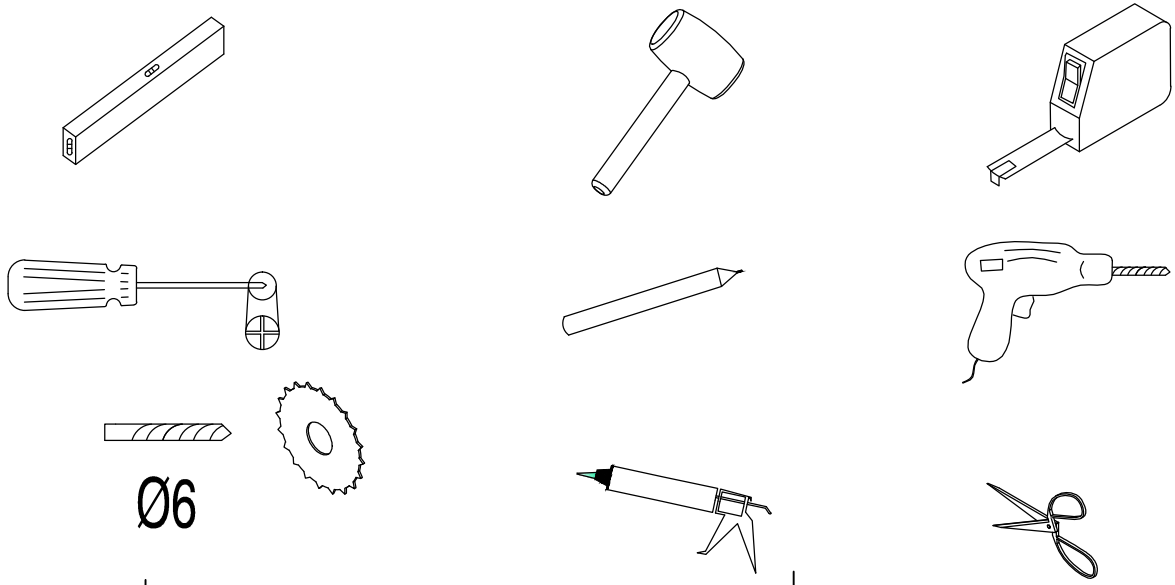

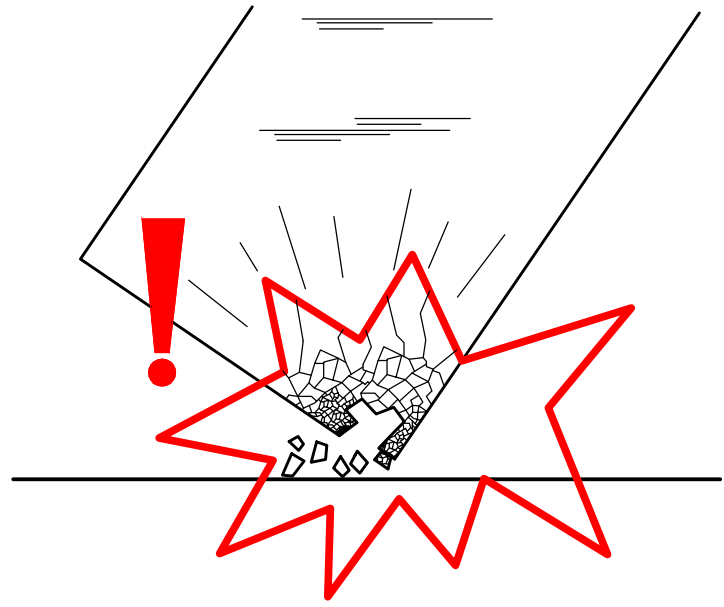

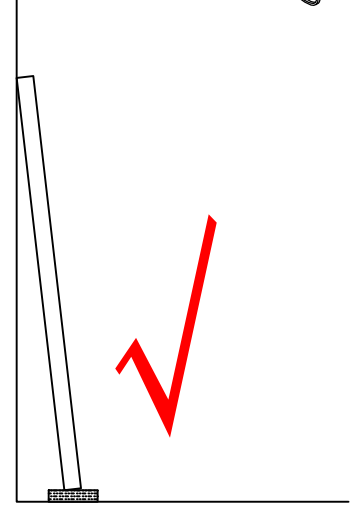

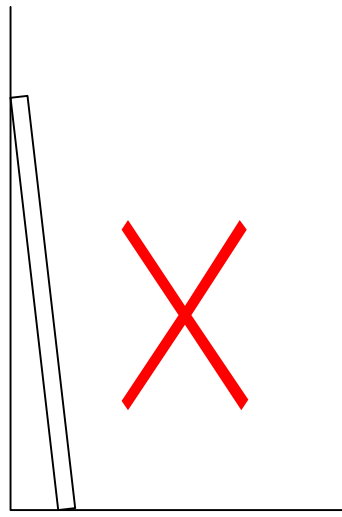

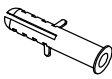

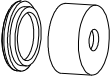
RGW-2882

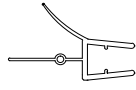
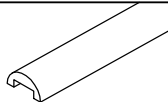
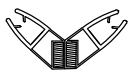
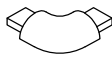
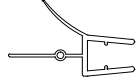





Ø6

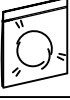

serial number	graphical	Parameter	quantity	remarks
1		∅6	6 PCS	
2			2 PCS	
3			6 PCS	
4			1 PCS	
5			2 PCS	
6			2 PCS	
7			1 PCS	
8			1 PCS	
9			2 PCS	
10			2 PCS	
11			1 PCS	
12		ST3. 9X35	6 PCS	
13		ST3. 5X9. 5	6 PCS	
14			2 PCS	
15			2 PCS	
16		M2. 5	1 PCS	

serial number	graphical	Parameter	quantity	remarks
17			1 PCS	
18		$\phi 2.8$	1 PCS	

Vaseline for pivot lubrication:

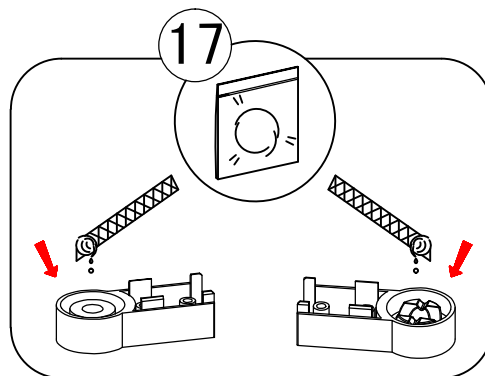

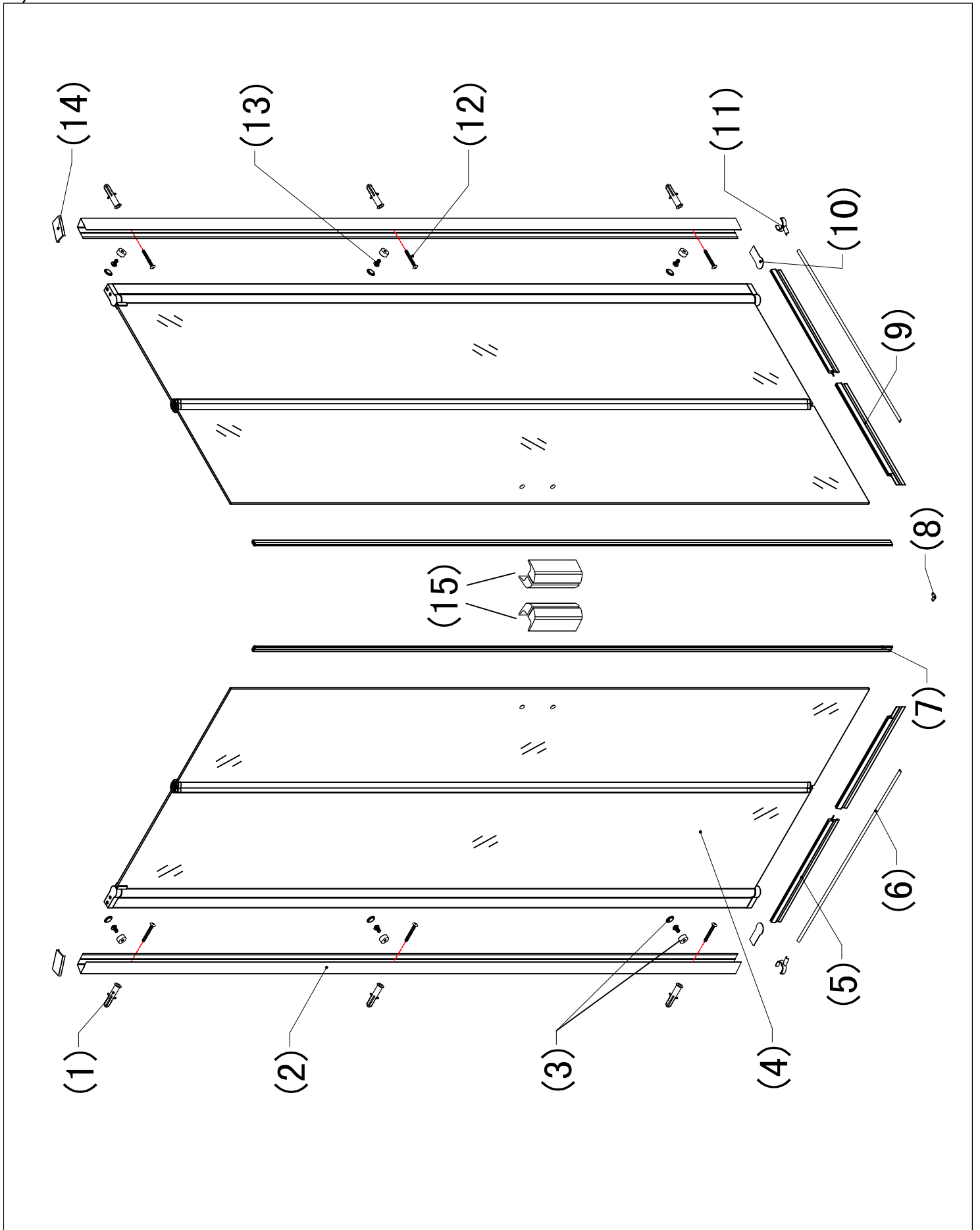

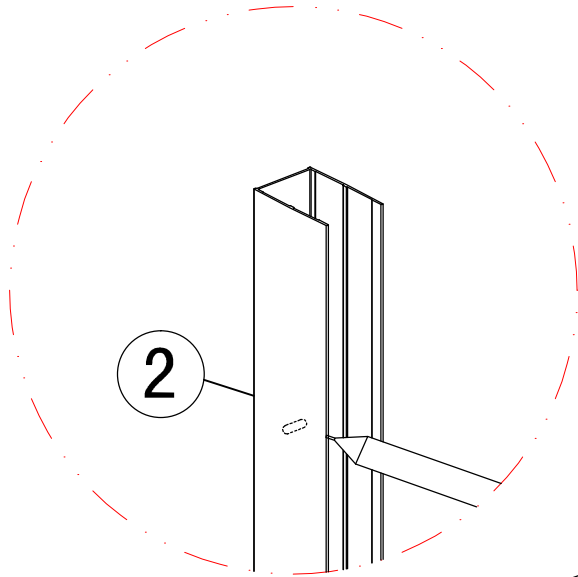

	a	b
700x900	685-705	885-905
900x900	885-905	885-905
700x1100	685-705	1085-1105

